

# Operation Manual of Controller

## SR501

### Un-pressurized Integrated Solar Hot Water Heater



 Please read the manual carefully before operation!

## Contents

1. Safety information .....	3
1.1 Installation and commissioning .....	3
1.2 Liability waiver .....	3
1.3 Signal description .....	4
2. Installation .....	4
2.1 Mounting controller .....	4
2.2 Power connection .....	5
2.3 Terminal port connection .....	5
2.4 Advice regarding the installation of temperature sensors .....	8
2.5 Installation of solenoid valve .....	8
2.6 Installation of sensor of temperature and water level .....	9
2.7 Bottom installation of sensor of temperature and water level .....	10
3. System diagram .....	11
4. Functions operation .....	11
4.1 Signals on display and function code .....	12
4.2 Button description .....	12
4.3 Menu structure .....	14
4.4 Menu description .....	14
5. Main functions setup (for users) .....	16
5.1 Time setting .....	16
5.2 Timing filling and heating with three time-sections .....	17
5.3 Temperature controlled water filling function .....	19
6. Additional functions setting (for professionals) .....	20
6.1 CTH Thermostat heating function .....	20
6.2 LWPR Low water pressure protection .....	21
6.3 CWL constant water level filling function (preset 100% water level of tank) .....	22
6.4 PUMP water filling pump .....	23
6.5 TCYC Setting the temperature / flow for DHW pump running within three time-sections .....	23
6.6 AH Automatic thermostat function .....	28
6.7 OTF Timer function .....	30
6.8 TKPR Tank high temperature protection function .....	31

6.9 CFR Tank anti-freezing protection .....	32
6.10 LWS Preset the water level of water filling when tank is lack of water .....	32
6.11 LWSD delay time of water filling when tank is lack-of water .....	33
6.12 OTDI Thermal disinfection .....	33
6.13 UNIT Celsius degree and Fahrenheit unit switch .....	34
6.14 BEEP Beeper error warning .....	34
7. Manual functions .....	35
7.1 Manual water filling .....	35
7.2 Compulsive water filling function .....	35
7.3 Manual heating .....	35
7.4 Manual DHW circulation .....	36
7.5 Factory reset manually function .....	36
7.6 Sensor sensitivity adjustment .....	36
8. Pipe anti-freezing protection function .....	37
9. View the measuring value .....	38
10. Protection function .....	39
10.1 Overflow protection .....	39
10.2 High temperature protection of collector tube .....	39
10.3 Memory protection .....	39
10.4 Screen protection .....	39
10.5 Trouble protection .....	39
10.6 Error code description .....	39
11. Quality Guarantee .....	40
12. Technical specification .....	40
13. Delivery list .....	40
14. Optional Accessories .....	41

## **1. Safety information**

We have carefully checked the text and pictures of this manual and provided the best of our knowledge and ideas, however inevitable errors maybe exist. Please note that we cannot guarantee that this manual is given in the integrity of image and text, incorrect, incomplete and erroneous information and the resulting damage we do not take responsibility.

### **1.1 Installation and commissioning**

- When laying wires, please ensure that no damage occurs to any of the constructional fire safety measures presented in the building.
- The controller must not be installed in rooms where easily inflammable gas mixtures are presented or may occur.
- The permissible environmental conditions can't be exceeded at the site of installation.
- Before connecting the device, make sure that the energy supply matches the specifications that controller requires.
- All devices connected to the controller must conform to the technical specifications of the controller.
- All operations on an open controller are only to be conducted cleared from the power supply. All safety regulations for working on the power supply are valid.
- Connecting and /or all operations that require opening the collector (e.g. changing the fuse) are only conducted by specialists.

### **1.2 Liability waiver**

The manufacturer can't monitor the compliance with these instructions or the circumstances and methods used for installation, operation, utilization and maintenance of this controller. Improper installation can cause damages to material and person. This is the reason why we do not take over responsibility and liability for losses, damages or cost that might arise due to improper

installation, operation or wrong utilization and maintenance or that occurs in some connection with the above-mentioned. Moreover, we do not take over liability for patent infringements or infringements occurring with the use of this controller on the third parties' rights. The manufacturer reserves the right to put changes to product, technical data or installation and operation instructions without prior notice. As soon as it becomes evident that safe operation is no longer possible (e.g. visible damage). Please immediately take the

device out of operation. **Note:** ensure that the device can't be accidentally placed into operation.

### 1.3 Signal description



**Safety indication:** Safety instructions in the text are marked with a warning triangle. They indicate measures which can lead to injury of person or safety risks.



**Operation steps:** small triangle “▶” is used to indicate operation step. **Notes:** Contains important information about operation or functions.

## 2. Installation

### 2.1 Mounting controller

Dimension of controller for electrical heater of 1500W:

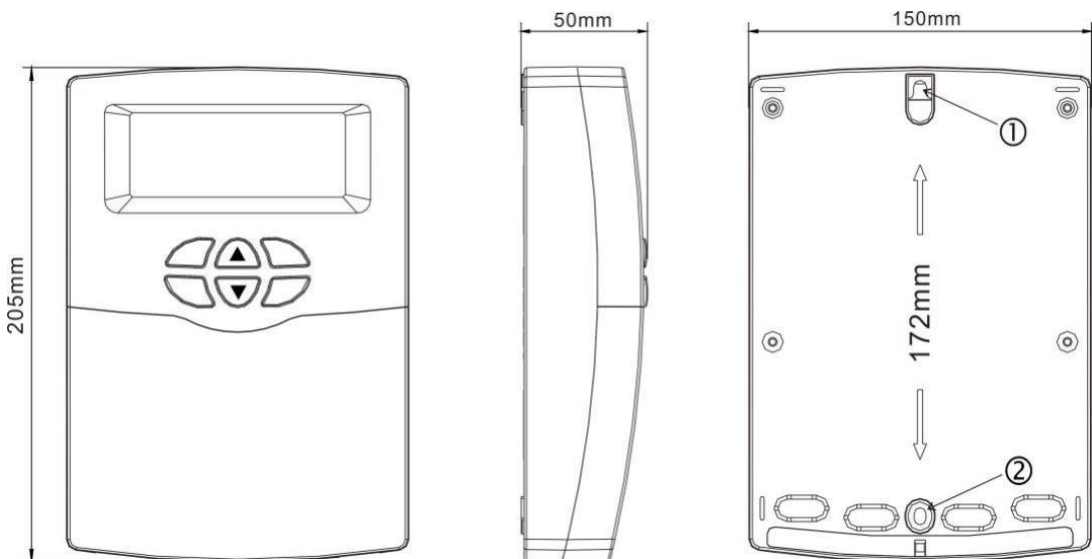

This controller can only be installed in the place having an adequate level of protection.

- ▶ Choosing a suitable site
- ▶ Drilling the upper fixing hole ①
- ▶ Screwing on the screw
- ▶ Taking away the cover plate
- ▶ Hanging the bottom plate on the fixing hole ①
- ▶ Marking the position of bottom fixing hole ②
- ▶ Taking away the bottom plate
- ▶ Drilling the hole ②
- ▶ Re-hanging the bottom plate on screw ①

- ▶ Fixing bottom plate with screw ②

## 2.2 Power connection

Depending on the type of installation, the cables may enter the device through the rear hole of the case ③ or the base side hole of the case ④

**Notes:** the flexible wire must be fastened to the case using the strain-relief clamps provided.

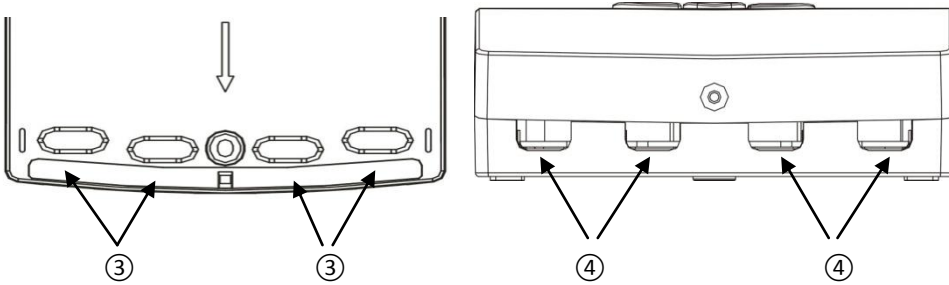

## 2.3 Terminal port connection



Before opening the terminal, please be sure to switch-off the power and pay attention to the local electricity supply rules.

### ➤ Terminal layout of controller for electrical heater of 1500W

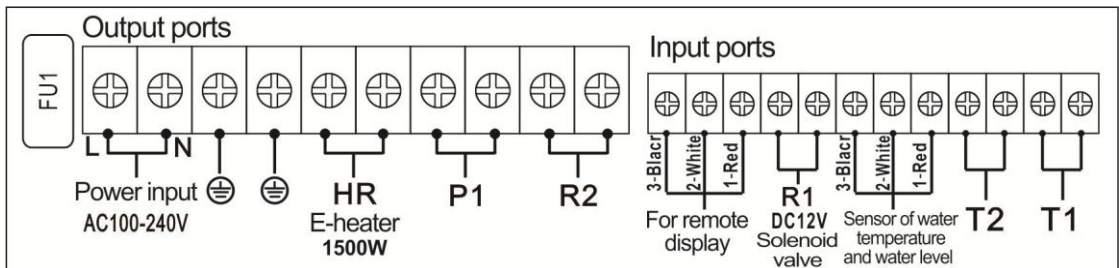

- **FU1:** the fuse of controller, AC250V/2A
- **Power input L, N:** 10A, for power connection, L: live wire, N: zero wire, protective ground wire, please connect the ground reliably.
- **Output ports**
  - **HR: Electromagnetic relays, designed for on/off control of back-up heating device, Max. Current: 10A ( @AC230V, for  $\leq 1500W$  electrical heater, @110VAC, for  $\leq 750W$  electrical heater)**
    - **P1:** designed for anti-freezing heating cables, electromagnetic relay, max. power is 500W.

- **R1:** designed for the solenoid valve of water filling, output power is DC12V, wire connection is not positive and negative difference.
- **R2:** designed for the electric tracing belt, electromagnetic relay, maximum current is 2A.



With Auxiliary electrical heating, the user must install the leakage protector himself.

- **SR501 Remote display (optional accessory)**

SR501 (1500W) controller is designed to be able to connect to a remote display, and on display, it is possible to set up the functions like manually water filling, manually trigger heating, manually trigger DHW circulation, On/off device, checking temperature and water level of the water tank and so on.



Remote display connection to the controller:

- ✧ Port 1: connect red wire (+12V)
- ✧ Port 2: connect white wire (COM)
- ✧ Port 3: connect black wire (GND)

**i** **Note:**

- 1) The remote display interface is not configured on the standard SR501 controller, if need a remote display, then the controller needs to be customized.
- 2) Remote display is not included in the standard parts of delivery, which should be purchased separately.
- 3) The maximum length of connection wire between the remote display and SR501 controller is not exceeded 45 m

- **Input ports**

- Sensor of water temperature and water level of the water tank(B03):
  - ✧ Port 1: connect red wire (+12V)
  - ✧ Port 2: connect white wire (COM)
  - ✧ Port 3: connect black wire (GND)
- **T1:** for NTC10K, B=3950,  $\leq 135^{\circ}\text{C}$  temperature sensor (PVC cable  $\leq 105^{\circ}\text{C}$ ), designed for DHW circulation TCYC or AH function (optional)
- **T2:** for NTC10K, B=3950,  $\leq 135^{\circ}\text{C}$  sensor (PVC cable  $\leq 105^{\circ}\text{C}$ ), designed for pipe anti-freezing function (optional)

**i** **Note:** T1, T2 temperature sensors are not included in the standard parts of delivery, which should be purchased separately.

➤ **Terminal layout of controller for electrical heater of 3000W**

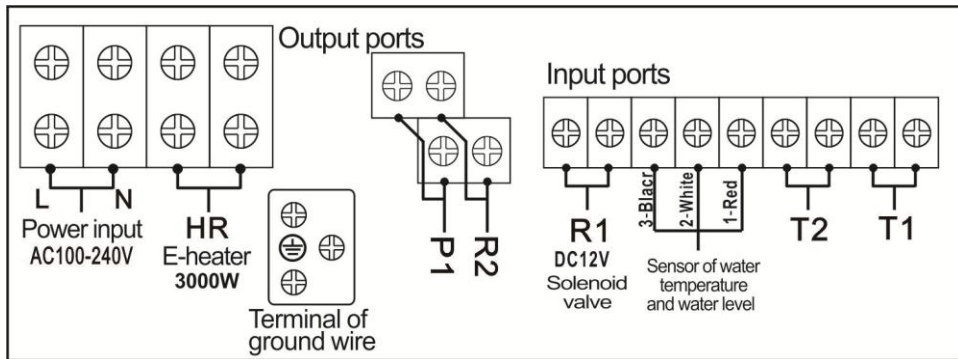

- **Power input N, L:** 20A, for power connection, L: live wire, N: zero wire, protective ground wire, please use 2mm<sup>2</sup> cable to connect the ground reliably.

Leakage of electricity switch  
AC220V/40A

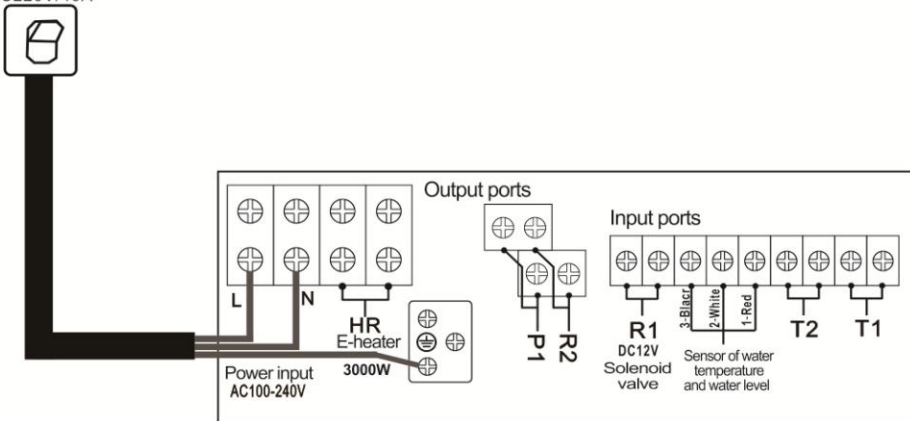

- **Output ports**
- **HR:** Electromagnetic relays, designed for on/off control of back-up heating device, **Max. Current: 16A ( @AC230V, for ≤3000W electrical heater, @110VAC, for ≤1500W electrical heater)**
- **P1:** electromagnetic relay, max. power is 200W.
- **R1:** designed for the solenoid valve of water filling, output power is DC12V, wire connection is not positive and negative difference.
- **R2:** electromagnetic relay, designed for the electric tracing belt, maximum current is 2A.





With Auxiliary electrical heating, the user must install the leakage protector himself.

- **Input ports**

- Sensor of water temperature and water level of the water tank(B03):
  - ✧ Port 1: connect red wire (+12V)
  - ✧ Port 2: connect white wire (COM)
  - ✧ Port 3: connect black wire (GND)
- **T1:** for NTC10K, B=3950,  $\leq 135^{\circ}\text{C}$  temperature sensor (PVC cable  $\leq 105^{\circ}\text{C}$ ), designed for DHW circulation TCYC or AH function (optional)
- **T2:** for NTC10K, B=3950,  $\leq 135^{\circ}\text{C}$  sensor (PVC cable  $\leq 105^{\circ}\text{C}$ ), designed for pipe anti-freezing function (optional)



**Note:**

- 1) SR501-3KW has no remote display function.
- 2) T1, T2 temperature sensors are not included in the standard parts of delivery, which should be purchased separately.

## 2.4 Advice regarding the installation of temperature sensors

- T1, T2 sensor cables carry low voltage, and to avoid inductive effects, must not be laid close to 230 Volt or 400 Volt cables (minimum separation of 100mm).
- T1, T2 sensor cables may be extended to a maximum length of ca. 100 meter, when cable's length is up to 50m, and then  $0.75\text{mm}^2$  cable should be used. When cable's length is up to 100m, and then  $1.5\text{mm}^2$  cables should be used.

## 2.5 Installation of solenoid valve

- Flushing pipe and cleaning pipe before mounting the solenoid valve
- If water is provided by water tower, to avoid no water filling or water flow rate is too low at solenoid valve, please select the solenoid valve which pressure is matched to the hydraulic pressure got from water tower.

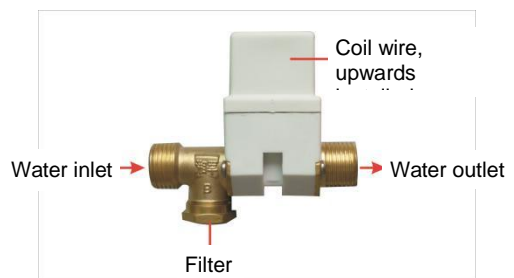

- Check whether the required voltage labelled on the type plate of solenoid valve is same to the voltage of power output of controller, check whether the filter of solenoid valve is completed, whether the body of valve has no damage. And during installation please pay attention to the water flow and return of solenoid valve, side with filter is the water input, water flow direction and arrow

signal on the body of solenoid valve should be aligned in same direction.

- Solenoid valve should be indoor installed at the place where is easy for maintenance or at the area where no more connected loss happened. To keep a long lifetime of solenoid valve, please pay attention to anti-frost, sun protection and prevent broken damage from freezing or aging of body of solenoid valve.
- It is prohibited to use a wrench worked on the coil wire and plastic parts, to ensure no damaged during installation and no torsion effect positioned on the solenoid valve, it is not allowed to install valve compulsively when tow connectors are not aligned.
- Two-cores wire is used for connection with solenoid valve, if wire needs to be lengthened, please select cable of 1.0mm<sup>2</sup>.
- To easy clean the filter, water inlet pipe connected to the solenoid valve should be a kind of soft pipe or pipe is easily dismantled.

**i** **Note:** one-way check valve integrated into the solenoid valve, so no one-way valve needs to be installed.

### 2.6 Installation of sensor of temperature and water level

- Sensor of water temperature and water level is inserted into tank from the overflow connector.
- Fasten sensor with the mutter of sensor.
- 3-cores wire of sensor connected to the input port of controller
  - Port 1: connect red wire (+12V)
  - Port 2: connect white wire (COM)
  - Port 3: connect black wire (GND)

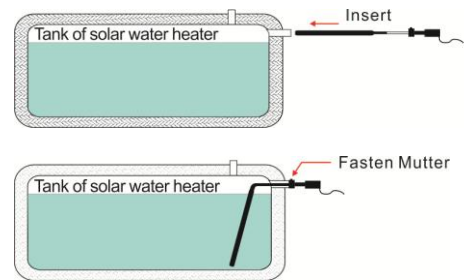

Picture 1

**i** **Note:**

1).Depending on the way of difference installation, we provide three different sensors, and the customer chooses one of them as needed. If the customer does not specify anything, we will follow the factory default configuration.

a).**”Side mounted sensor”**

(factory default configuration) see the picture 1

b).**”Top mounted sensor”**

(need to be specified in order) see the picture2

c).**”Bottom mounted sensor”**

(Need to be specified in order) refer the details of Paragraph 2.7

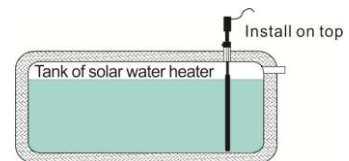

Picture 2

2). To avoid the measuring error or damage the sensor, sensor of temperature and water level must not touch or close to the e-heater tube

### **2.7 Bottom installation of sensor of temperature and water level**

There are 2 installation ways for positioning the sensor of temperature and water level on the bottom part of tank: one way is inserting sensor from hole of collector, the other is inserting sensor from bottom of tank. Diameter of installation hole is 47mm.



Sensor installed on the bottom collector tube hole

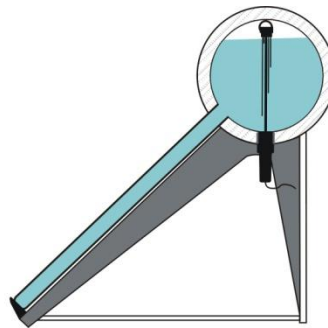

Sensor installed on the bottom of tank

### 3.System diagram

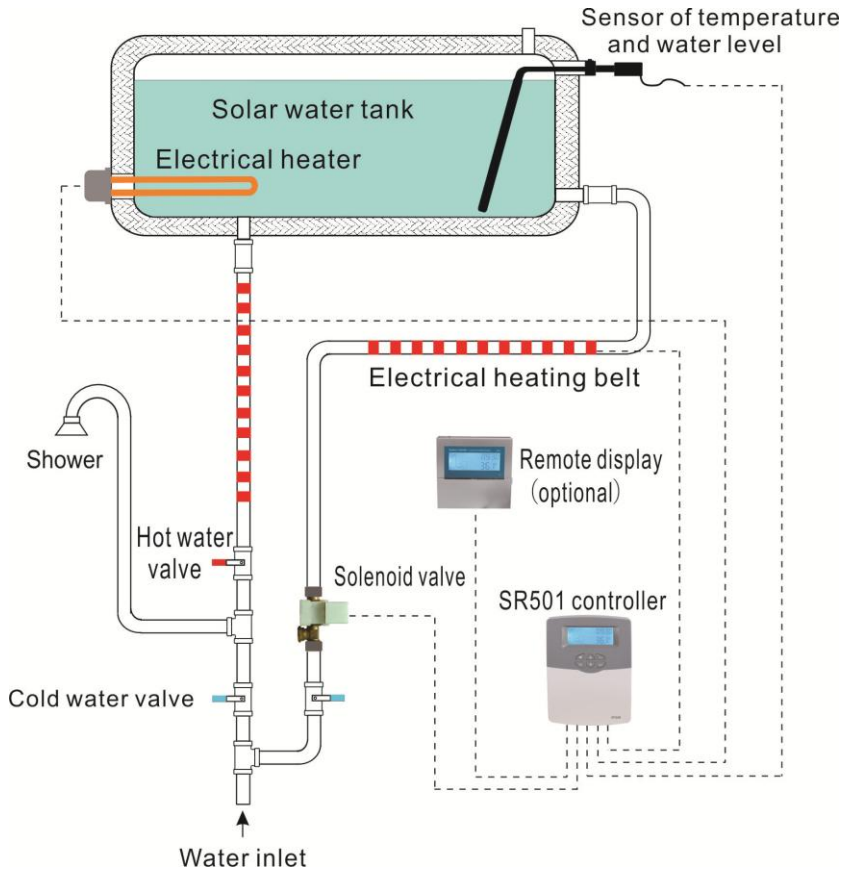

**i** Note: this diagram is only for reference.







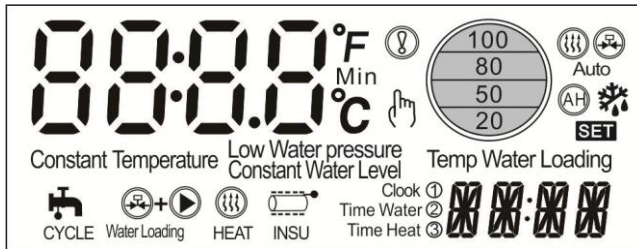

### 4. Functions operation

Before switching-on the power, please connect sensor of temperature and water level, water filling solenoid valve to the input port of controller, connect electrical heater to the output port of controller. And then switching-on power, the controller runs an initialization phase for 5 seconds, then controller runs a commissioning menu, it leads the user through the most important adjustment channels needed for operating the system.

4.1 Signals on display and function code



LCD display screen

Code	Description	Code/Signal Lighting	Code/Signal Blink
 Constant Temperature	Thermostat heating	Function is activated	Function is running
OTDI	Thermal disinfection function (check under menu inquiry)		Countdown of disinfection function working (DDIS)
OTF	Timer ( check under menu inquiry)		
 INSU	Temperature controlled pipe heating belt	Function is activated	Function is running
 INSU	Time controlled pipe heating belt	Function is activated	Function is running
	Timing heating function	Function is activated	Function is running
	Temperature controlled DHW within 3 time - sections	Function is activated	Function is running
	Water flow controlled DHW within 3 time - sections	Function is activated	Function is running
AH	Automatic thermostat	Function is activated	Function is running
	Anti-freezing protection(check under menu inquiry)	Function is activated	Function is running
	Manual function		
	Fault alarm of sensor of temperature and water level		

4.2 Button description

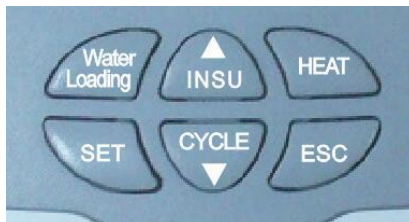

Buttons layout on the controller

- **Button description**

- “Water Loading” button: water filling manually (detailed see section 7.1)
- “HEAT” button: heating manually (detailed see section 7.3)
- “SET” button: access the menu or activate the set value
- “ESC” button: confirm the setting value and ESC or return to the previous menu
- “▲” button: increase adjustable value or upwards menu
- “▼” button: decrease adjustable value or downwards menu
- Press “▲” for 3 seconds: switch on/off the pipe anti-freezing function (see detailed in the section 6.9)
- Press “▼” for 3 seconds: switch on/off manual DHW circulation function (at the case function TCYC DHW circulation function is enabled) (see detailed in section 6.4)
- Press “SET” button for 3 seconds: to access addition main menu
- Press “ESC” button for 3 seconds: to check the on/off status of auxiliary functions (includes functions like: low water pressure function, disinfection function, anti-freezing function, timer function, tank high temperature protection function)

- **Main menu operation steps**

- ▶ 1. Press “SET” button to access the menu of timer, timing water filling and timing heating function
- ▶ 2. Press “SET” button for 3 seconds to access main menu of auxiliary functions
- ▶ Press “▲▼” to adjust the main menu
- ▶ Press “SET” to access submenu

- **Submenu operation steps**

- ▶ Press “SET” to access submenu
- ▶ Press “SET” again to the adjustable item, press “▲▼” to select “ON” to activate the option, or select “OFF” to deactivate this option
- ▶ Press “SET” or “ESC” to confirm the adjust
- ▶ Press “▲” to access the next submenu
- ▶ Press “SET” to set the adjustable value
- ▶ Press “▲▼” to adjust value
- ▶ Press “SET” or “ESC” to confirm the adjust



**Note:** after accessing the adjust channel, if no any button is pressed for 3 minutes, then display returns to the main interface.

4.3 Menu structure

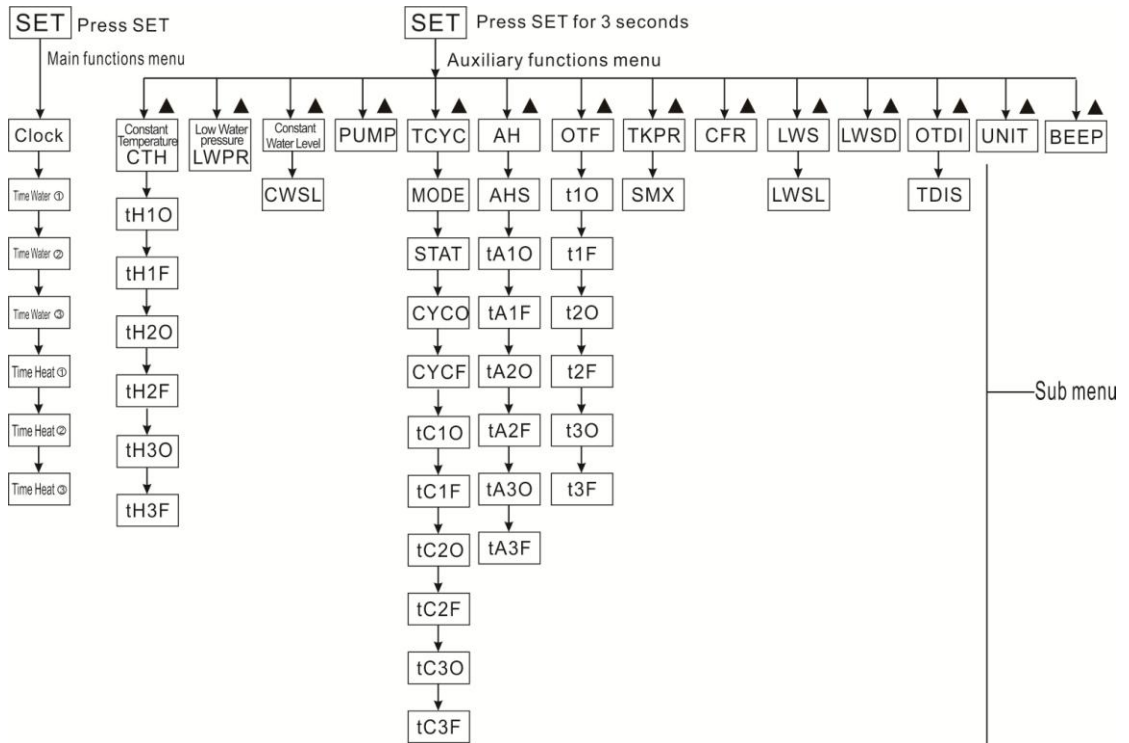

- Controlled can be detailed set through the submenu, please understand and get familiar with the submenu.

4.4 Menu description

Main functions menu (for users)			
Code (Main menu)	Code (Submenu)	Default value	Description
Clock			Clock
Time Water			Timing water filling
	Time Water 1	03:00 / 50%	Time and water level of the 1st time water filling
	Time Water 2	09:00 / 100%	Time and water level of the 2nd time water filling
	Time Water 3	16:00 / 100%	Time and water level of the 3rd time water filling
Time Heat			Timing heating
	Time Heat 1	04:00 / 50°C	Time and temperature of the 1st time water heating
	Time Heat 2	10:00 / 0°C	Time and water level of the 2nd time water heating
	Time Heat 3	17:00 / 60°C	Time and water level of the 3rd time water heating

## SR501 EN Operation Manua

Auxiliary functions menu (for professionals)			
Code (Main menu)	Code (Submenu)	Default value	Description
CTH			Thermostat heating function
	tH1O	00:00/55°C	Switch-on time and temperature of the 1 <sup>st</sup> time section of CTH function
	tH1F	23:59/60°C	Switch-off time and temperature of the 1 <sup>st</sup> time section of CTH function
	tH2O	00:00/55°C	Switch-on time and temperature of the 2 <sup>nd</sup> time section of CTH function
	tH2F	00:00/60°C	Switch-off time and temperature of the 2 <sup>nd</sup> time section of CTH function
	tH3O	00:00/55°C	Switch-on time and temperature of the 3 <sup>rd</sup> time section of CTH function
	tH3F	00:00/60°C	Switch-off time and temperature of the 3 <sup>rd</sup> time section of CTH function
LWPR		ON	Low water pressure protection function of water filling
CWL		OFF	Constant water level: tank is full, water level 100%
	CWSL	80%	Water level of filling It is able to set as 0%, 20%, 50%, 80%, when tank water level drops to the set water level, water will be filled automatically to 100% water level.
PUMP		OFF	On/off of water filling pump (output port is P1), note: when water filling pump(p1 voltage AC220V) function is enable, P1 and solenoid valve will be on/off synchronously.
TCYC		OFF	DHW circulation controlled by temperature and water flow in three-time sections (output port: P1)
	MODE	FS/TEP	Control mode selection between water flow of DHW circulation control or temperature control
	STAT	ON	Trigger-on condition of temperature controlled DHW circulation
	CYCO	37°C/03 minute	Switch-on temperature/time
	CYCF	42°C/10 minute	Switch-off temperature/time
	tC1O	00:00	Switch-on time of the 1 <sup>st</sup> time section
	tC1F	23:59	Switch-off time of the 1 <sup>st</sup> time section
	tC2O	00:00	Switch-on time of the 2 <sup>nd</sup> time section
	tC2F	00:00	Switch-off time of the 2 <sup>nd</sup> time section
	tC3O	00:00	Switch-on time of the 3 <sup>rd</sup> time section
	tC3F	00:00	Switch-off time of the 3 <sup>rd</sup> time section
AH		OFF	Automatic thermostat function (output port: P1)
	AHS	tst / S1	Sensor selection for automatic thermostat function (tst indicates tank temperature, S1 indicates T1 temperature sensor)
	AHO	40°C	Switch-on temperature
	AHF	45°C	Switch-off temperature
	tA1O	00:00	Switch-on time of the 1 <sup>st</sup> time section
	tA1F	23:00	Switch-off time of the 1 <sup>st</sup> time section
	tA2O	00:00	Switch-on time of the 2 <sup>nd</sup> time section



## SR501 EN Operation Manua

	tA2F	00:00	Switch-off time of the 2 <sup>nd</sup> time section
	tA3O	00:00	Switch-on time of the 3 <sup>rd</sup> time section
	tA3F	00:00	Switch-off time of the 3 <sup>rd</sup> time section
OTF		OFF	Timer function (output port: P1)
	t 1O	00:00	Switch-on time of the 1 <sup>st</sup> time section
	t 1F	00:00	Switch-off time of the 1 <sup>st</sup> time section
	t 2O	00:00	Switch-on time of the 2 <sup>nd</sup> time section
	t 2F	00:00	Switch-off time of the 2 <sup>nd</sup> time section
	t 3O	00:00	Switch-on time of the 3 <sup>rd</sup> time section
	t 3F	00:00	Switch-off time of the 3 <sup>rd</sup> time section
TKPR		ON	Tank high temperature protection
	SMX	80°C	Temperature of water filling at tank high temperature protection function
CFR		ON	Anti-freezing protection
LWS	LWSL	50%	Water level of water filling at lack of water protection function
LWSD		30minute	Water filling run-on time at lack of water protection function
OTDI		OFF	High temperature disinfection function
	TDIS	70°C	Temperature for disinfection
UNIT		°C	Temperature unit selection °C/°F
BEEP		ON	Fault alarm



**Note:** functions TCYC, AH, OTF, PUMP is allocated with a same output port P1, so only one can be activated form 4 functions, then the others will be off automatically, and its function status displays NONE.

for example: if PUMP water filling pump function is set to “on”, then if you want to trigger AH function, then you need to close the function PUMP firstly.

## 5. Main functions setup (for users)

### 5.1 Time setting

▶ Press “SET” button, time displays on the screen, ▶ Press “SET” button again, hour “00” blinks on the screen.

▶ Press “▲▼” button to set hour of clock

▶ Repress “SET”, minute “00” blinks

▶ Press “▲▼” button to set minute of clock.

▶ Press “SET” or “ESC” to confirm setting, the set parameters are saved automatically.





**Note:** at the case that power is switched-off, time can be remembered for 36 hours.

## 5.2 Timing filling and heating with three time-sections

### Timing water filling description:

Within 24 hours, three time-sections of water filling can be set. When time of filling water comes, water is automatically filled into tank to the set water level. When water is being used (water level drops), the water filling is delayed for 30 minutes to start.

### Timing heating description:

Electrical heater can be integrated into solar system used as back-up heating of system, and it can be triggered automatically at preset time by preset temperature. Within a preset time-section, when the temperature of tank drops below the preset switch-on temperature of this function, electrical heater starts to work, when temperature rises to the preset switch-off temperature, electrical heater is stopped. When water level is lower than 50% during a heating time-section, to avoid a dry heating, water is filled to the level of 50% firstly, then the electrical heater is triggered to heat to the desired temperature.

### Timing filling and heating factory default reference as below:

- The first time: at 3:00 a.m. to fill water to the water level of 50%, at 4:00 a.m. to trigger electrical heater to heat water to the temperature of 50oC, to provide hot water for users just after getting up.
- The second time: at 9:00 a.m. to fill water to the water level of 100%, and electrical heater doesn't work, to use solar irradiation to heat water.
- The third time: at 16:00 p.m. to fill water to the 100% water level, and at 17:00 p.m. to trigger electrical heater to heat water up to the temperature of 60oC for night using.



**Note:**

- 1) Above parameters can be set base on the user's habit.
- 2) When water is using (water level drops), then water filling is delayed for 30 minutes to start.

Code (Main menu)	Code (Submenu)	Default value	Adjustable arange	Description
Time Water				Timing water filling
	Time Water 1	03:00 / 50%	00:00- 23:59 20-100%	Time and water level of the 1st time water filling
	Time Water 2	09:00 / 100%	00:00- 23:59 20-100%	Time and water level of the 2nd time water filling
	Time Water 3	16:00 / 100%	00:00- 23:59 20-100%	Time and water level of the 3rd time water filling

## SR501 EN Operation Manua

Time Heat				Timing heating
	Time Heat 1	04:00 / 50°C	00:00- 23:59 0-95°C	Time and temperature of the 1st time water heating
	Time Heat 2	10:00 / 0°C	00:00- 23:59 0-95°C	Time and water level of the 2nd time water heating
	Time Heat 3	17:00 / 60°C	00:00- 23:59 0-95°C	Time and water level of the 3rd time water heating

### Setup steps:

- ▶ Press “SET” button, time displays on the screen.
- ▶ Press “▲” button, time of the 1<sup>st</sup> timing water filling (Time Water ①) 03:00, water level 50% displays.
- ▶ Press “SET” button, hour “03” blinks on the screen.
- ▶ Press “▲▼” button, to set hour
- ▶ Press “SET” button, minute “00” blinks on the screen.
- ▶ Press “▲▼” button, to set minute
- ▶ Press “SET” button, water level “50%” blinks on the screen.
- ▶ Press “▲▼” button, to set water level
- ▶ Press “SET” or “ESC” button to confirm the setting.
- ▶ Press “▲” button, time of the 2<sup>nd</sup> timing water filling (Time Water ②) displays.

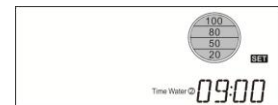

Repeat above steps to set the time and water level of the second and the third of timing water filling (“Time Water ②” and “Time Water ③” ).

- ▶ Press “▲” button, timing heating “Time Heat ①” displays.
- ▶ Press “SET” button, hour “04” blinks on the screen.
- ▶ Press “▲▼” button, to set hour
- ▶ Press “SET” button, minute “00” blinks on the screen.
- ▶ Press “▲▼” button, to set minute
- ▶ Press “SET” button, temperature “50°C” blinks on the screen.
- ▶ Press “▲▼” button, to set temperature ( adjustable range: 0-90°C)
- ▶ Press “SET” or “ESC” button to confirm the setting.





Repeat above steps to set the time and temperature of the second and the third of timing heating (“Time Heat ②” and “Time Heat ③”).



### Note:

- 1). Hold “HEAT” button for 3 seconds to activate or deactivate “timing heating” function.

- 2). Hold “Water Loading” button for 3 seconds to activate or deactivate “timing filling” function.
- 3). Icon instructions for “timing filling” and “timing heating”

ICONS	Description of Icon	Remarks
 Auto	Both of “timing filling” available and “timing heating” are available	Equivalent to winter mode
 Auto	Only “timing filling” available	Equivalent to summer mode
 Auto	Only “timing heating”	Equivalent to winter mode
The “Auto” icon disappear	Both of “timing filling” and “timing heating” are deactivate	Equivalent to summer mode

### 5.3 Temperature controlled water filling function

Description:

When this function is activated, then water filling is controlled by temperature which set by user. When sensor get the signal that water is not full filled and water temperature is higher than the temperature for water filling, then controller starts water filling automatically, when water temperature is 2°C below the set temperature or water level is to 100% level, water filling is stopped.

When water is using (water level drops), to avoid water filling under this case, water filling is delayed for 30minutes to start. (and default temperature controlled time: 8:00-17:00).

Activate and deactivate the function, steps as below:

- ▶ Hold “Water Loading” button for 3 seconds to activate temperature controlled water filling function
- ▶ Press “▲▼” button, to set temperature of water filling ( adjustable range: 35°C-95°C, factory set: 60°C)
- ▶ Press “ESC” button to confirm the setting. The functions is activated.
- ▶ Hold “Water Loading” button for 3 seconds again to deactivate temperature controlled water filling function.



**i Note:** when this function is activated, then the timing water filling is deactivated.

**6. Additional functions setting (for professionals)**

Press “SET” for 3 seconds to access the additional functions menu.

**6.1 CTH Thermostat heating function**

Description:

Purpose of this function is ensuring user can get enough hot water. when tank temperature is reached to the switch-on temperature, the electrical heater is triggered immediately to heat tank, and when temperature reaches to the desired temperature, electrical heater is stopped. The process is repeated according to the condition and ensures tank temperature is always constant at the set temperature.

Three heating time-sections can be set within a day.

Factory set (unchangeable):

- The first heating time starts at 00:00 and closes at 23:59, switch-on temperature is 55°C, and switch-off temperature is 60°C.
- The second heating time starts at 00:00 and closes at 00:00, the heating function is deactivated.
- The third heating time starts at 00:00 and closes at 00:00, the heating function is also deactivated.

Thermostat heating can works within three time-sections, its adjustable range of the switch-on temperature of heating is 0°C-(OFF-2°C), its adjustable range of the switch-off temperature of heating is (ON+2°C)-95°C

**i** Note: if you want closed thermostat heating in one time-section, just set its start time is same as its ending-time. (for example, within second time-section, you set its start time is 00:00, and set the ending time is also 00:00)

Code (Main menu)	Code (Submenu)	Default value	Adjustable arange	Description
CTH				Thermostat heating function
	tH1O	00:00/55°C	00:00- 23:59 0-93°C	Switch-on time and temperature of the 1 <sup>st</sup> time section of CTH function
	tH1F	23:59/60°C	00:00- 23:59 2-95°C	Switch-off time and temperature of the 1 <sup>st</sup> time section of CTH function
	tH2O	00:00/55°C	00:00- 23:59 0-93°C	Switch-on time and temperature of the 2 <sup>nd</sup> time section of CTH function
	tH2F	00:00/60°C	00:00- 23:59 2-95°C	Switch-off time and temperature of the 2 <sup>nd</sup> time section of CTH function

## SR501 EN Operation Manua

	tH3O	00:00/55°C	00:00- 23:59 0-93°C	Switch-on time and temperature of the 3 <sup>rd</sup> time section of CTH function
	tH3F	00:00/60°C	00:00- 23:59 2-95°C	Switch-off time and temperature of the 3 <sup>rd</sup> time section of CTH function

Setup steps:

Select CTH thermostat heating main menu.

▶ Press “SET” button, “CTH Constant Temperature OFF” shows on the screen.

▶ Press “SET” button, “OFF” blinks

▶ Press “▲▼” button, to activate this function.

▶ Press “SET” or “ESC” button to confirm the setting.

▶ Press “▲” button, “tH1O 00:00” displays on the screen (start time of the 1st time section of thermostat heating)

▶ Press “SET” button, hour “00” blinks

▶ Press “▲▼” button, to adjust hour.

▶ Press “SET” button, minute “00” blinks

▶ Press “▲▼” button, to adjust minute.

▶ Press “SET” button, temperature “55°C” blinks

▶ Press “▲▼” button, to adjust switch-on temperature, adjustable range is 0-93°C, factory set is 55°C.

▶ Press “SET” or “ESC” button to confirm the setting.

▶ Press “▲” button, “tH1F 23:59” displays on the screen (end time of the 1st time section of thermostat heating).

Repeat above steps to set the ending time and ending temperature of the 1st time section.

▶ Press “▲” button, “tH2O 00:00” displays on the screen (start time of the 2nd time section of thermostat heating), repeat above steps to set time and temperature of 2nd and 3rd time sections.

**i** **Note:** if water level is below 50%, to avoid dry heating, it is needed to trigger water filling and fill water position above 50% level.

## 6.2 LWPR Low water pressure protection

Description:

During the water filling process, due to low water pressure or water supply stopping (water level can't be raised to the upper level within 60 minutes), controller will trigger the low water pressure protection function, and “low water pressure” signal shows on the screen, to avoid

damaging the solenoid valve due to its long-time running, the protection function will be deactivated after 60 minutes

When the "low water pressure" icon flashes, the controller will automatically shut down the "water loading function" to prevent the leaks of the vacuum tube and the pipeline.

**Recover water loading function:** To power off ,then re-powering on controller.

Deactivated this function:

Select the LWPR low water pressure protection menu.

- ▶ Press “SET” button, “LWPR low water pressure ON” shows on the screen.
- ▶ Press “SET” button, “ON” blinks
- ▶ Press “▲▼” button, to deactivate this function.
- ▶ Press “SET” or “ESC” button to confirm the setting.



**i Note:** under standby status, hold “ESC” button to access the inquiry function, there you can check the on / off status of this function.

### 6.3 CWL constant water level filling function (preset 100% water level of tank)

Description:

When water level drops from it full level of 100% to the preset water level at which to start water filling, solenoid valve is opened immediately, and water is filled until 100% water level.

Code (Main menu)	Code (Submenu)	Default value	Adjustable arange	Description
CWL		OFF		Constant water level: tank is full, water level 100%
	CWSL	80%	0-80%	Water level of filling It is able to set as 0%, 20%, 50%, 80% , when tank water level drops to the set water level, water will be filled automatically to 100% water level.

Set this function:

Select menu CWL.

- ▶ Press “SET” button, “CWL constant water level OFF” shows on the screen.
- ▶ Press “SET” button, “OFF” blinks
- ▶ Press “▲▼” button, to activate this function.
- ▶ Press “SET” or “ESC” button to confirm the setting.
- ▶ Press “▲” button, water level zone “80%” shows on the screen
- ▶ Press “SET” button, water level zone “80%” blinks.
- ▶ Press “▲▼” button, to adjust the water level.



▶ Press “SET” or “ESC” button to confirm the setting.

## 6.4 PUMP water filling pump

Description:

In the areas where water pressure is lower, then a pressure pump P1 should be installed in the solar system, when the water filling conditions is matched, water filling pump P1 and solenoid valve R1 will be triggered or closed at the same time. (if output P1 is allocated to the other functions, then status of this function is showed NONE)

Set this function:

Select menu PUMP.

▶ Press “SET” button, “PUMP OFF” shows on the screen.

▶ Press “SET” button, “OFF” blinks

▶ Press “▲▼” button, to activate this function.

▶ Press “SET” or “ESC” button to confirm the setting.



## 6.5 TCYC Setting the temperature / flow for DHW pump running within three time-sections

Description:

Purpose of this function is ensuring user can get hot water quickly. 2 control modes are designed in this controller:

- Timing temperature controlled mode
- Timing flow rate controlled mode.

For this function, a DHW circulation pump P1 and flow switcher or a temperature sensor T1 mounted on the DHW return pipe should be installed in the system. (when output P1 is allocated to the other functions, this function shows NONE).

### DHW pump running at below 2 modes:

- controlled by flow switcher within the three time-sections
- controlled by temperature within the three time-sections



### Note:

- 1) Only one of two control modes can be selected to control DHW pump.
  - 2) The setting steps for time controlled mode and temperature controlled mode is same.
- **DHW pump controlled by temperature within the three time-sections (tEP)**



Sensor T1 is connected to the controller and temperature controlled mode is selected automatically, within a running time section, as default set, DHW pump P1 runs when T1 is below 37°C, and DHW pump P1 stops when T1 reaches to 42°C

Startup condition for temperature controlled mode (STAT): when tank temperature is 2°C higher than the preset switch-off temperature(CYCF), and then DHW circuit pump is triggered.

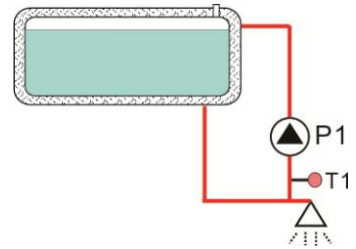

Default time sections:

- The first time-section starts at 00:00 a.m., ends at 23:59 p.m.
- The second time-section starts at 00:00 a.m., ends at 00:00 p.m.
- The third time-section starts at 00:00 a.m., ends at 00:00 p.m.

**i Note:** If sensor T1 should be installed, to avoid measuring error, please ensure a safety distance of 1.5m to tank.

● **DHW pump controlled by flow switcher within the three time-sections (FS)**

Description:

Install a flow switcher on the cold-water pipe, and then open the tap, when there is flow through the hot water pipe, flow switcher gets signal and sends it to controller, and then DHW pump is triggered to transport the hot water from tank to tap. The running time of DHW pump is adjustable, running time finished, DHW pump is stopped.

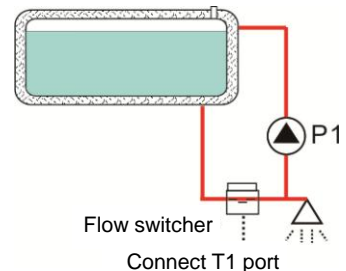

Tap seems like a remote controller, it controls the running of DHW pump. This control mode of DHW pump is an energy saving solution.

Open the tap for a short time, then flow switcher installed on the cold-water pipe will get the flow signal and sends it to the controller, and then controller triggers DHW pump P1 to transport the hot water from tank into circulation pipe. Then when you open the tap again, hot water can flow out immediately, the running time finishes, DHW pump will stop automatically. When no more hot water is needed, to avoid hot water is cooled by circulation, DHW pump will be stopped when its running time finished. And to avoid the DHW pump is triggered

again just after its stop, a parameter of interval time is designed for this purpose.

as default set, DHW pump runs for 3 minutes (adjustable range 1-30 minutes) and then ceases for 10 minutes (adjustable range 0-60 minute), same process repeated within the running time section. Running time can be adjusted from 1-30Min; interval time can be adjusted from 0-60Min.

**i** Note:

- 1) To avoid the mixing of water in the tank with water in the circulation pipe, a one-way valve should be installed before pump.
- 2) If the interval time (CYCF) is set to 0 minute, then within the time-section, DHW pump keeps running without any intervals. Close the tap, pump is ceased automatically.

Default time sections:

- The first time-section starts at 00:00 a.m., ends at 23:59 p.m.
- The second time-section starts at 00:00 a.m., ends at 00:00 p.m.
- The third time-section starts at 00:00 a.m., ends at 00:00 p.m.

● Flow switcher fitting:

Material: Brass

House: plastics

Connection: G3/4

Reed: Max 300VDC/1A



**i** Note:

- 1) Pay attention to the water flow direction of flow switcher when you install it.
- 2) Flow switcher is connected to port T1 with either polarity.
- 3) Flow switcher is not included in the standard delivery list, if need please purchase it separately.
- 4) Only one of two control modes can be selected to control DHW pump, it is impossible to use them at the same time.
- 5) When water level of tank is lower than 20%, to avoid pump dry running controller will deactivate the circulation pump automatically

## SR501 EN Operation Manua

Code (Main menu)	Code (Submenu)	Default value	Adjustable arange	Description
TCYC		OFF		DHW circulation controlled by temperature and water flow in three-time sections (output port: P1)
	MODE	FS/tEP		Control mode selection between water flow of DHW circulation control or temperature control
	STAT	ON		Trigger-on condition of temperature controlled DHW circulation
	CYCO	37 °C /03 minute	5-53°C 1-30Min	Switch-on temperature/time
	CYCF	42 °C /10 minute	7-55°C 0-60 Min	Switch-off temperature/time
	tC1O	00:00	00:00- 23:59	Switch-on time of the 1 <sup>st</sup> time section
	tC1F	23:59	00:00- 23:59	Switch-off time of the 1 <sup>st</sup> time section
	tC2O	00:00	00:00- 23:59	Switch-on time of the 2 <sup>nd</sup> time section
	tC2F	00:00	00:00- 23:59	Switch-off time of the 2 <sup>nd</sup> time section
	tC3O	00:00	00:00- 23:59	Switch-on time of the 3 <sup>rd</sup> time section
	tC3F	00:00	00:00- 23:59	Switch-off time of the 3 <sup>rd</sup> time section

### Setup steps (example with temperature controlled mode)

▶ Select menu TCYC to access the main menu and select menu “TCYC”.



▶ Press “SET” button again, “TCYC OFF” displays on the screen.

▶ Press “SET” button, “OFF” blinks on the screen.

▶ Press “▲▼” button, to activate this function

▶ Press “SET” or “ESC” button to confirm.

▶ Press “▲” button, “MODE FS” displays on the screen, to select the DHW pump control mode



▶ Press “SET” button again, “FS” blinks on the screen.

▶ Press “▲▼” button, to select control mode

▶ Press “SET” or “ESC” button to confirm.

▶ Press “▲” button, “STAT ON” displays (startup temperature of DHW pump, this menu is only displayed under temperature control mode)

▶ Press “SET” button again, “ON” blinks on the screen (default is on) .



▶ Press “▲▼” button, to deactivate this function

▶ Press “SET” or “ESC” button to confirm.

▶ Press “▲” button, “CYCO 37°C” displays (switch –on temperature of DHW pump, if control mode flow switcher is selected, then here “CYCO 03MIN” displays)



▶ Press “SET” button again, “37 °C” blinks on the screen.

▶ Press “▲▼” button, to adjust switch-on temperature, adjustable range 5 °C~(OFF-2 °C), factory set is 37°C

▶ Press “SET” or “ESC” button to confirm.

▶ Press “▲” button, “CYCF 42°C” displays (switch –off temperature of DHW pump)

▶ Press “SET” button again, “42 °C” blinks on the screen.

▶ Press “▲▼” button, to adjust switch-off temperature, adjustable range (ON+2 °C) ~55 °C, factory set is 42°C.



▶ Press “SET” or “ESC” button to confirm.

▶ Press “▲” button, to the first time-section setting, “tC 1O 00:00” displays (switch –on time of the first time-section of DHW pump)

▶ Press “SET” button again, hour “00” blinks on the screen.

▶ Press “▲▼” button, to adjust hour of the switch-on time

▶ Press “SET” button again, minute “00” blinks on the screen.

▶ Press “▲▼” button, to adjust minute of the switch-on time

▶ Press “SET” or “ESC” button to confirm.



▶ Press “▲” button, to the first time-section setting, “tC 1F 23:59” displays (switch–off time of the first time-section of DHW pump)

▶ Press “SET” button again, hour “23” blinks on the screen.

▶ Press “▲▼” button, to adjust hour of the switch-off time

▶ Press “SET” button again, minute “59” blinks on the screen.

▶ Press “▲▼” button, to adjust minute of the switch-off time

▶ Press “SET” or “ESC” button to confirm.



▶ Press “▲” button, to the second time-section setting, repeat above steps to set the second time-section and the third time-section.

**i Note:**

If it is needed to close one time-section, just set its start time and stop time at a same value (e.g. 10:00 starts, 10:00 stops)

When DHW pump signal  displays and blinks, it indicates that temperature controlled DHW pump mode is running.

When signal  displays and blinks, it indicates the flow switcher controlled DHW pump mode is running.

**6.6 AH Automatic thermostat function**

Automatically thermostat function is independent from solar system, it is used to release the extra heat to reduce the tank temperature or to trigger back-up heater to heat tank to the desired temperature. This function needs an electromagnetic valve or circulation pump P1, corresponding temperature sensor is T1 or tst (when the output P1 is allocated to the other functions, this function shows NONE).

** Note:**

AHO<AHF: this thermostat function is used to control the back-up heater

AHO>AHF: this thermostat function is used to release the extra heat from tank

Code (Main menu)	Code (Submenu)	Default value	Adjustable arange	Description
AH		OFF		Automatic thermostat function (output port: P1)
	AHS	tst / S1		Sensor selection for automatic thermostat function (tst indicates tank temperature, S1 indicates T1 temperature sensor)
	AHO	40°C	0-95°C	Switch-on temperature
	AHF	45°C	0-94.5°C	Switch-off temperature
	tA1O	00:00	00:00- 23:59	Switch-on time of the 1 <sup>st</sup> time section
	tA1F	23:00	00:00- 23:59	Switch-off time of the 1 <sup>st</sup> time section
	tA2O	00:00	00:00- 23:59	Switch-on time of the 2 <sup>nd</sup> time section
	tA2F	00:00	00:00- 23:59	Switch-off time of the 2 <sup>nd</sup> time section
	tA3O	00:00	00:00- 23:59	Switch-on time of the 3 <sup>rd</sup> time section
	tA3F	00:00	00:00- 23:59	Switch-off time of the 3 <sup>rd</sup> time section

Setup steps:

- ▶ Select main menu AH
- ▶ Press “SET” button, parameter “OFF” blinks on the screen
- ▶ Press “▲▼” to activate this function
- ▶ Press “SET” or “ESC” button to confirm the set.
- ▶ Press “▲” button, parameter “AHS S1” appears (sensor elected for this function, S1 presents T1, tst presents tank temperature)

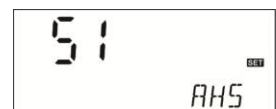

- ▶ Press “SET” button, parameter “S1” blinks on the screen
- ▶ Press “▲▼” to select sensor
- ▶ Press “SET” or “ESC” button to confirm.

▶ Press “▲” button, “AHO 40°C displays on the screen, to set the switch-on temperature of this function.



- ▶ Press “SET” button, temperature “40°C” blinks on the screen
- ▶ Press “▲▼” to adjust temperature, adjustable range is 0-95°C, factory set is 40°C.
- ▶ Press “SET” or “ESC” button to confirm.

▶ Press “▲” button, “AHF 45°C displays on the screen. to set the switch-off temperature of this function.



- ▶ Press “SET” button, temperature “45°C” blinks on the screen
- ▶ Press “▲▼” to adjust temperature, adjustable range is 0-94.5°C, factory set is 45°C.
- ▶ Press “SET” or “ESC” button to confirm.

▶ Press “▲” button to access three time-sections setting program of the thermostat function, “tA1O 00: 00 ”displays, it is ready for set the start time of the first time-section.



- ▶ Press “SET” button, hour “00” blinks on the screen
- ▶ Press “▲▼” to set hour of the start time
- ▶ Press “SET” button, minute “00” blinks on the screen
- ▶ Press “▲▼” to set minute of the start time
- ▶ Press “SET” or “ESC” button to confirm.

▶ Press “▲” button to access three time-sections setting program of the thermostat function, “tA1F 23:59”displays, it is ready for set the end time of the first time-section.

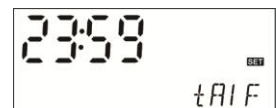

- ▶ Press “SET” button, hour “23” blinks on the screen
- ▶ Press “▲▼” to set hour of the start time
- ▶ Press “SET” button, minute “59” blinks on the screen
- ▶ Press “▲▼” to set minute of the start time
- ▶ Press “SET” or “ESC” button to confirm.

▶ Press “▲” button to access the second time-section setting, repeat above steps to set the start time and end time of the second and the third time-section.

When the signal of thermostat “AH” blinks on the screen, it indicates that the thermostat function is running.

### 6.7 OTF Timer function

**Description:**

Controller has timer function, within the set time section, output P1 is switched-on; outside the time section, and then output P1 is switched-off (when output P1 is allocated to the other functions, its status shows NONE).

Code (Main menu)	Code (Submenu)	Default value	Adjustable arange	Description
OTF		OFF		Timer function (output port: P1)
	t 1O	00:00	00:00- 23:59	Switch-on time of the 1 <sup>st</sup> time section
	t 1F	00:00	00:00- 23:59	Switch-off time of the 1 <sup>st</sup> time section
	t 2O	00:00	00:00- 23:59	Switch-on time of the 2 <sup>nd</sup> time section
	t 2F	00:00	00:00- 23:59	Switch-off time of the 2 <sup>nd</sup> time section
	t 3O	00:00	00:00- 23:59	Switch-on time of the 3 <sup>rd</sup> time section
	t 3F	00:00	00:00- 23:59	Switch-off time of the 3 <sup>rd</sup> time section

**Setup steps:**

- ▶ Select OTF Timer function menu.
- ▶ Press “SET” button, “OFF” displays on the screen.
- ▶ Press “▲▼”button to activate the function
- ▶ Press “SET” or “ESC” to confirm



- ▶ Press “▲” button to access three time-sections setting program of the timer function, “t 1O 00: 00 ”displays, it is ready for set the start time of the first time-section.

- ▶ Press “SET” button, hour “00” blinks on the screen
- ▶ Press “▲▼” to set hour of the start time
- ▶ Press “SET” button, minute “00” blinks on the screen
- ▶ Press “▲▼” to set minute of the start time
- ▶ Press “SET” or “ESC” button to confirm.



- ▶ Press “▲” button to access three time-sections setting program of the time, “t1F 00:00”displays, it is ready for set the end time of the first time-section.

- ▶ Press “SET” button, hour “00” blinks on the screen



- ▶ Press “▲▼” to set hour of the start time
- ▶ Press “SET” button, minute “00” blinks on the screen
- ▶ Press “▲▼” to set minute of the start time
- ▶ Press “SET” or “ESC” button to confirm.
  
- ▶ Press “▲” button to access the second time-section setting, repeat above steps to set the start time and end time of the second and the third time-section.

**i Note:**

- 1) If it is needed to close one time-section, just set its start time and end time at a same value (e.g. 10:00 starts, 10:00 ends)
- 2) Under standby status, hold “ESC” button to access the inquiry function, there you can check the on or off status of this function. press “▲” to check, “OTF ON” indicates the timer function is activated. “ON” blinks, it indicates the timer function is running.

**6.8 TKPR Tank high temperature protection function**

Description:

To prevent tank from damaging caused by high temperature, when tank temperature rises to the switch-on protection temperature, default is 80°C, water filling will be triggered, it will stop until tank temperature drops to 78°C (default set is 2°C hysteretic) or water level is to 100%. When water is using (water level is dropping), then water filling is delayed for 30 minutes to start. (this tank protection function is time limited, it can only be triggered from 8:00-17:00).

Code (Main menu)	Code (Submenu)	Default value	Adjustable arange	Description
TKPR		ON		Tank high temperature protection
	SMX	80°C	50-95°C	Temperature of water filling at tank high temperature protection function

**Setup steps:**

- ▶ Select main menu TKPR tank high temperature protection function
- ▶ Press “SET” button, “TKPR ON” displays on the screen
- ▶ Press “▲” button, “SMX 80°C” displays on the screen.
- ▶ Press “SET” button, “80°C” blinks
- ▶ Press “▲▼” button to adjust temperature of high temperature protection, adjustable range is 50-95°C, factory set is 80°C.
- ▶ Press “SET” or “ESC” to confirm





## 6.9 CFR Tank anti-freezing protection

### Description:

In winter, when outdoor temperature is very low, to avoid freezing of collector tube/ tank, when controller measures the tank temperature drops to only 3°C (factory set, not adjustable), controller will trigger the electrical heater to heat tank until its temperature rises to 7°C, and then tank anti-freezing function is deactivated automatically.

### Setup steps:

- ▶ Select main menu CFR tank anti-freezing protection function
- ▶ Press “SET” button, “CFR ON” displays on the screen
- ▶ Press “SET” button, “ON” blinks
- ▶ Press “▲▼” button to activate or deactivate the function
- ▶ Press “SET” or “ESC” to confirm



When anti-freezing signal ❄️ blinks, it indicates anti-freezing function is activated.

### **i** Note:

Under standby status, hold “ESC” button to access the inquiry function, there you can check the on or off status of this function. Press “▲” button to check, “CFR ON” indicates this function is activated.

## 6.10 LWS Preset the water level of water filling when tank is lack of water

### Description:

Water level drops from its high level to the low level, when water level is lower than 20%, then automatic water filling is delayed 30 minutes to start and it fills water to the preset water level 50% (factory set).

**i** Note: according to the customer demand, the preset water filling level and run-on time can be set under menu (detailed see sections 6.10 and 6.11)

Code (Main menu)	Code (Submenu)	Default value	Adjustable arange	Description
LWS	LWSL	50%	20-100%	Water level of water filling at lack of water protection function

### Setup steps:

- ▶ Select main menu LWS water filling level function
- ▶ Press “SET” button, “LWSL” displays and water level zone “50%” displays also on the screen
- ▶ Press “SET” button, “50%” blinks



▶ Press “▲▼”button to adjust the preset water level, adjustable range is 20-100%, factory set is 50%.

▶ Press “SET” or “ESC” to confirm

**6.11 LWSD delay time of water filling when tank is lack-of water**

Code (Main menu)	Code (Submenu)	Default value	Adjustable arange	Description
LWSD		30minute		Water filling run-on time at lack of water protection function

Setup steps:

▶ Select main menu LWSD delay time of water filling when tank is lack-of water

▶ Press “SET” button, “LWSD 30 min” displays on the screen

▶ Press “SET” button, delay time “30” blinks

▶ Press“▲▼”button to adjust the delay time, adjustable range is 0-90-minute, factory set is 30 minutes.

▶ Press “SET” or “ESC” to confirm



**6.12 OTDI Thermal disinfection**

**Description:**

To avoid occurring bacteria in water tank, controller will trigger the back-up heater to heating tank to the required temperature to kill the bacteria. Therefore, tank temperature is monitoring by controller at the monitoring period (PDIS) (default is 7 days), if the temperature is not reached to the desired disinfection temperature (TDIS) during this monitoring period PDIS, then controller will trigger the electrical heater at the preset start time (SDIS), and controller will heat tank and ensure the temperature during the heating period (DDIS) is always higher than the desired disinfection temperature (TDIS). When thermal disinfection function is working (DDIS time starts), DDIS countdown time starts (default is 10 minutes), countdown time finished, thermal disinfection heating is stopped, and then this function stops.

Code (Main menu)	Code (Submenu)	Default value	Adjustable arange	Description
OTDI		OFF		High temperature disinfection function
	TDIS	70°C	60-90°C	Temperature for disinfection

Setup steps:

▶ Select TDIS thermal disinfection main menu



- ▶ Press “SET” button, “OTDI OFF” displays on the screens
- ▶ Press “SET” button, “OFF” blinks
- ▶ Press “▲▼” button, to activate this function
- ▶ Press “SET” or “ESC” to confirm

▶ Press “▲” button, to set the temperature of disinfection, “TDIS 70°C” displays on the screen.

▶ Press “SET” button, “70°C” blinks

▶ Press “▲▼” button, to set the temperature of thermal disinfection, adjustable range is 60-90°C, factory set is 70°C.

▶ Press “SET” or “ESC” to confirm

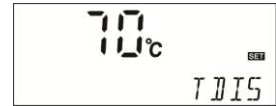

**i Note:**

Under standby status, hold “ESC” button to access the inquiry function, there you can check the on or off status of this function.

### 6.13 UNIT Celsius degree and Fahrenheit unit switch

**Setup steps:**

- ▶ Select this function menu UNIT,
- ▶ Press “SET” button, “TEMP °C” displays on the screen
- ▶ Press “SET” button again, “°C” blinks
- ▶ Press “▲▼” to switch the temperature unit
- ▶ Press “SET” or “ESC” to confirm

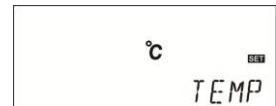

### 6.14 BEEP Beeper error warning

When temperature and water level sensor, T1 temperature sensor has error, this function will send warning to manager (detailed see section 10.6 error code).

When beeper sounds, press any button to ESC the warning function.

**Setup step:**

- ▶ Select BEEP warning function menu
- ▶ Press “SET” button, “BEEP ON” displays
- ▶ Press “SET” button, “ON” blinks
- ▶ Press “▲▼” button to activate or deactivate the function
- ▶ Press “SET” or “ESC” to confirm



## 7. Manual functions

### 7.1 Manual water filling

Description:

When water in the solar tank is not full, user needs to fill water immediately, then press “Water Loading” button to start water filling.

Activate and deactivate this function:

- ▶ Press “Water Loading” button, then water level of water filling signal blinks on the screen
- ▶ Continuously press “Water Loading” button, water level of tank can be set (50%-100%)
- ▶ Press “ESC” button or wait for 6 seconds to confirm the setting, and water is filling now.

### 7.2 Compulsive water filling function

Description:

If sensor of temperature and water level is out of working, “E0” displays on the screen, then you can trigger water filling function compulsively.



- ▶ Press “Water Loading” button for 3 seconds to trigger compulsive water filling function, (countdown 8 minutes), countdown time and water level of 0%,20%,50%,80% and 100% displays on the screen alternatively.
- ▶ Press “Water Loading” button again to stop the compulsive water filling function

### 7.3 Manual heating

Description:

It is possible to trigger back-up heater manually to heat the water to the desired temperature. When controller detects that the water temperature is lower than the preset switch-on temperature of manual heating function, controller will trigger heater to work until the water temperature rises to the desired temperature.

Activate and deactivate the function:

- ▶ Press “HEAT” button, temperature “60°C” displays on the screen.
- ▶ Press “▲▼” button to adjust the desired temperature, adjustable range: 0°C -80°C, factory set is 60°C.
- ▶ Press “HEAT” or “ESC” button or wait for 6 seconds to confirm the setting, heater starts to work, and manual heating signal   blinks on the screen.
- ▶ Press “HEAT” again to cease the manual heating function.



**i** **Note:** manual heating can only heat tank once, when manual heating function is triggered, water is heated to the desired temperature and then heating is stopped, this function is deactivated automatically.

## 7.4 Manual DHW circulation

Description: controller can trigger the DHW circulation pump manually.

When DHW circulation function is activated, means TCYC function is under standby:

- ▶ Press “▼” button for 3 seconds, DHW circulation signal “03 min” displays on the screen.
- ▶ Press “▲▼” button to adjust the running time, adjustable range: 1- 60-minute, factory set is 3 minutes.
- ▶ Press “ESC” button or wait for 6 seconds to confirm the setting, DHW circulation starts to work, and DHW circulation signal  blinks on the screen.
- ▶ Press “▼” for 3 seconds again to cease the manual DHW circulation function.

## 7.5 Factory reset manually function

Through this function, it is possible to recover all parameters to the factory set.

### Setup steps:

Under power-off status

- ▶ Hold “SET” button, then switch-on power, screen displays “MRST”, beeper sounds “di...” 3 times, and then release “SET” button, it indicates the controller program is recovered to the factory set.

## 7.6 Sensor sensitivity adjustment

Activate the function:

Under power off state

- ▶ Press “SET” button and hold on, then power on, when screen display “HRES” and hearing the buzzer “beep” 1 sound, release the “SET” button, it’s mean that the “water level and temperature sensor” has been adjusted to high sensitivity mode.

Deactivate the fuction:

- ▶ Press “SET” button and hold on, then power on, when screen display “HRES” and hearing the buzzer “beep” 1 sound, release the “SET” button, it’s mean that parameter load into factory default.

(The “water level and temperature sensor” has been turned off high sensitivity mode)

 **Note:** Hold for “ESC” button, access into inquiry menu, it’s inquiry sensitivity mode(HRES) state” on” or “off”.

## 8. Pipe anti-freezing protection function



**Note:** when user selects pipe anti-freezing temperature control mode, then sensor T2 should be connected to controller, sensor T2 is not included in the standard delivery list, it should be purchased separately.

Description:

2 control modes for pipe anti-freezing function are designed in this controller:

- 1) Temperature controlled pipe anti-freezing
- 2) Time controlled pipe anti-freezing

### • Temperature controlled pipe anti-freezing

In winter, when outdoor temperature is lower, controller will trigger the pipe anti-freezing protection function to avoid pipe broken due to freezing. A sensor T2 installed on the pipe is needed, when controller detects the T2 temperature is lower than the preset switch-on temperature of pipe anti-freezing function, controller will trigger the pipe electrical belt R2 to heat pipe until its temperature rises to the desired temperature.

For example: if you set the switch-on temperature is 1°C, then when T2 temperature drops below 1°C, pipe anti-freezing function is triggered, and it works until the T2 temperature rise to 6°C. Adjustable range is 0-90°C, hysteric temperature is 5°C.

### • Time controlled pipe anti-freezing

For time controlled pipe anti-freezing mode, at the pre-set time section, the running time of pipe belt heating is set to 10 minutes (default set, not adjustable), the interval time of pipe belt heating is set to 30 minutes (adjustable range 0-90 minute). Belt heating function runs for 10 minutes, then it stops for 30 minutes, this heating process is repeated within the time section, through this setting, it can avoid giving power to heating wires for long time, saving electricity and it can avoid fire due to aging of wire.

Activate and deactivate this function:

▶ Press “INSU” button for 3 seconds, working time “30min” of pipe anti-freezing function blinks on the screen

▶ Press “▲▼” button to adjust the interval time of pipe anti-freezing heating, adjustable range: 1-90-minute, factory set is 30 minutes.

▶ Press “INSU” button for 3 seconds again to cease the pipe anti-freezing function.

**i** Note:

- 1) Only after sensor T2 is installed, the temperature controlled pipe anti-freezing mode just can be available, its setting is same as time mode.
- 2) When sensor T2 is not installed or it is damaged, the control mode of pipe anti-freezing is switched to the time controlled mode.

**9. View the measuring value**

When controller works at normal status, by pressing “▲▼” button, it is possible to view the T1, T2 temperature value, controller running time, sensor running time and software version.

When controller works at normal status, press “ESC” button for 3 seconds, it is possible to check the on/off status of auxiliary functions (low water pressure function, disinfection function(TDIS), anti-freezing protection, timer function, tank high temperature protection function)

Code	Code description
DAYS	Running days of controller
SDAY	Running days of sensor
SW	Software version
LWPR	Low water pressure function
OTDI	Disinfection function
CFR	Anti-freezing protection function
OTF	Timer function
TKPR	Tank high temperature protection function

**i** Note:

- 1) T2 value can be viewed only when pipe anti-freezing function is activated.
- 2) At the view menu, if no any button is pressed within 3 minutes, display returns to the main interface.

## 10. Protection function

### 10.1 Overflow protection

When sensor of water temperature and water level occurs fault, it may cause overflow when water filling function is working, then controller will stop water filling automatically.

### 10.2 High temperature protection of collector tube

When water level is lower than 20% and water temperature is higher than 95°C, to avoid the collector tube exploded due to the thermal stress, water filling function will be stopped compulsively (“Water Loading” button is unable), and “E4” displays on the screen. When water temperature drops below 80°C, this protection function is deactivated, and water filling function is recovered.

### 10.3 Memory protection

In case power failure occurs, controller keeps the parameter settings unchanged.

### 10.4 Screen protection

When no any press on button for 5 minutes, screen protection is activated automatically, and LED backlight is dimmed by light. Through press any button to light LCD lamp again.

### 10.5 Trouble protection

When temperature sensor’s wiring is interrupted, not connected, controller switches off the corresponding signal output, and simultaneously error code displays on the screen to give a warning. When sensor is short circuit, then “88.8°C” displays on the screen.

### 10.6 Error code description

Error code	Error description	Display status
E0	Communication fault between controller and sensor of temperature and water level	Temperature zone displays “E0”
E1	Communication fault between controller and remote display	The remote display show”E1”
E3	Fault of solenoid valve	E3 and clock signal displays alternatively in every 4 seconds.
E4	Collector tube high temperature protection	E4 and clock signal displays alternatively in every 4 seconds.
	Temperature fault of sensor of temperature and water level	Temperature zone displays “----”



E7	Water level fault of sensor of temperature and water level	E7 and clock signal displays alternatively in every 4 seconds.
T1---	T 1sensor fault	T1--- and main interface displays alternatively in every 4 seconds.

**11. Quality Guarantee**

The warrantee expires within 12 months after the date of purchasing the controller.





**12. Technical specification**

- Power supply: AC100-240V,50-60Hz
- Power consumption: < 3W
- Accuracy of temperature measuring:  $\pm 1^{\circ}\text{C}$
- Range of tank temperature measuring: 0 ~100  $^{\circ}\text{C}$
- Inputs: temperature and water level sensor, 2\*NTC10K temperature sensor (optional)
- Outputs: 4 electromagnetic relays
- Ambient temperature :  $-10^{\circ}\text{C} \sim 50^{\circ}\text{C}$ .
- Water proof grade: IP40.

**13. Delivery list**

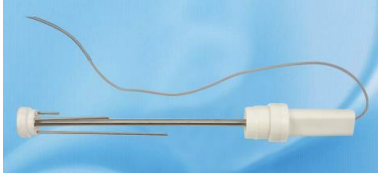
Controller ----- 1piece  
 User manual-----1piece  
 Sensor of water temperature and water level (with cable of 20m) -----1piece  
 Solenoid valve -----1piece  
 Accessories-----1bag  
 10A power cable (exclude in SR501-3KW version)-----1piece

14. Optional Accessories

Products name	Specification	Products picture
Bottom insert sensor	High quality temperature and water level sensor. Diameter of installation hole is 47mm.	
A02 (Sensor pocket)	High accurate sensor for tank and pipe NTC10K, B=3950, $\Phi 6 \times 50$ mm, with 3m cable	
A05	304 stainless steel with thread 1/2' OT, Size: $\Phi 8 \times 200$	
SR501D Remote display	Maximum length of connection wire between the remote display and SR501D not exceeded 45 m	
SR-43W (flow switch)	Material: Brass House: Plastic Connector: G3/4 Reed: Max 300V DC/1A	